



# ***Electrical Safety***

---

## ***Ground Fault Circuit Interrupters (GFCIs)***

***Dennis Burks, CSP***

***Sprint Nextel***

# *Electrical Injuries*

---

- *Approximately 1,000 deaths / year*
- *30,000 non-fatal electric shocks / year*
- *Electrocutions on low-voltage circuits*
  - *48% performing work on “hot” equipment*
  - *52% due to use of faulty power tools, electric lights, extension cords or defective outlets*
- *High-voltage electrocutions*
  - *29% electrical work*
  - *71% non-electrical work*

# *Electrical Safety*

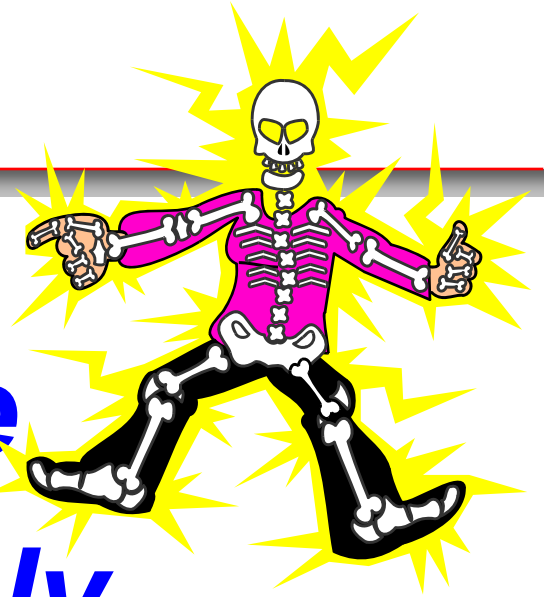

***Low Voltage  
Does Not Imply  
Low Hazard***

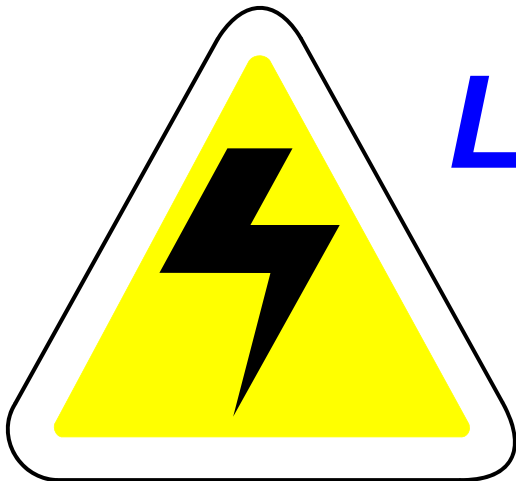

# *Electrical Hazards*

---

- *Electrical shock*
  - *Respiratory arrest*
  - *Cardiac arrest*
  - *Electrical burns*
- *Other hazards*
  - *Falls*
  - *Respiratory injury*
- *Fire ignition*
  - *Leading source of fires*
- *Arc flash*
  - *Thermal hazard - 35,000 degree Fahrenheit*
  - *Intense light*
- *Arc blast*
  - *Pressure waves*
  - *Sound waves*
  - *Shrapnel*
  - *Molten Metal*

# *Electrical Injuries*



# *Eye Injury From Arc Blast*



Photo — Courtesy of Potomac Electric Power Company.

**THE EYESIGHT OF THE OWNER  
OF THESE SAFETY GLASSES-A MEMBER OF  
IBEW LOCAL UNION 1900-WAS SAVED BECAUSE  
HE WORE HIS SAFETY EQUIPMENT!**

**DO YOU USE YOURS?**

**AN IBEW SAFETY REMINDER FOR OUR MEMBERS**

Reprinted from the IBEW Journal, Official Publication of the International Brotherhood of Electrical Workers (AFL-CIO)



# *Body Reactions to Electricity*

---

<b>AC Current</b>	<b>Effect on Human Body</b>
-------------------	-----------------------------

---

**1/2 to 2 ma - Some sensation**

**2 to 10 ma - Muscular contraction**

**5 to 10 ma - Painful shock**

**50 to 200 ma - Heart convulsions**

**over 100 ma - Paralysis of breathing**

---



# *Electrical Contact*

---

- *Severity of shock*
  - *Amount of current*
  - *Path the current flows through the body*
  - *Length of time current flows through the body*

# *Principles of Electricity*

---

## ■ *Voltage*

- *Electromotive force or potential difference, measured in volts*
- *“E” is the “pressure” that pushes an electrical charge through a conductor*

## ■ *Current*

- *Amount of electrical charge flowing past a given point per unit of time, measured in amperes*
- *“I” is the measure of electrical current flow*

## ■ *Resistance*

- *Opposition to electrical current flow, measured in ohms*

# *Principles of Electricity*

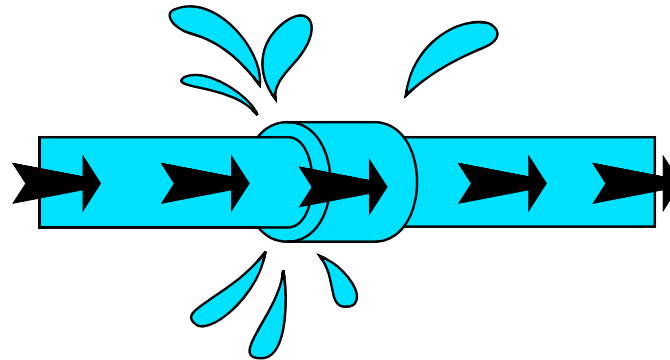
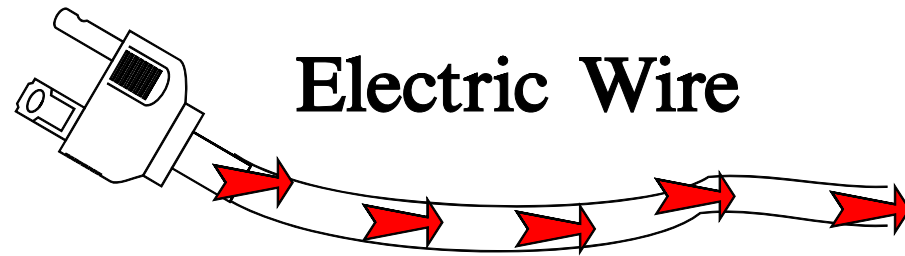

Water Pipe

*Electricity is the flow of current and it works only when current is flowing.*

# *Three Secrets of Electricity*

- *Electricity does not spring into action until current flows.*
- *Electricity will not flow until you have a complete loop or circuit.*
- *Current always wants to return to the source.*

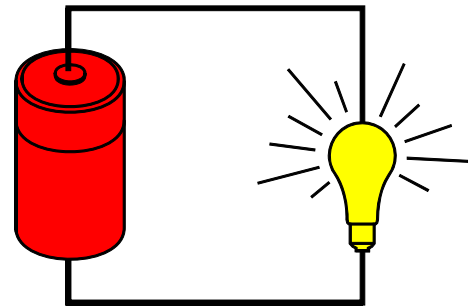

*(Electricity is the flow of current and it works only when current is flowing.)*

# *Principles of Electricity*

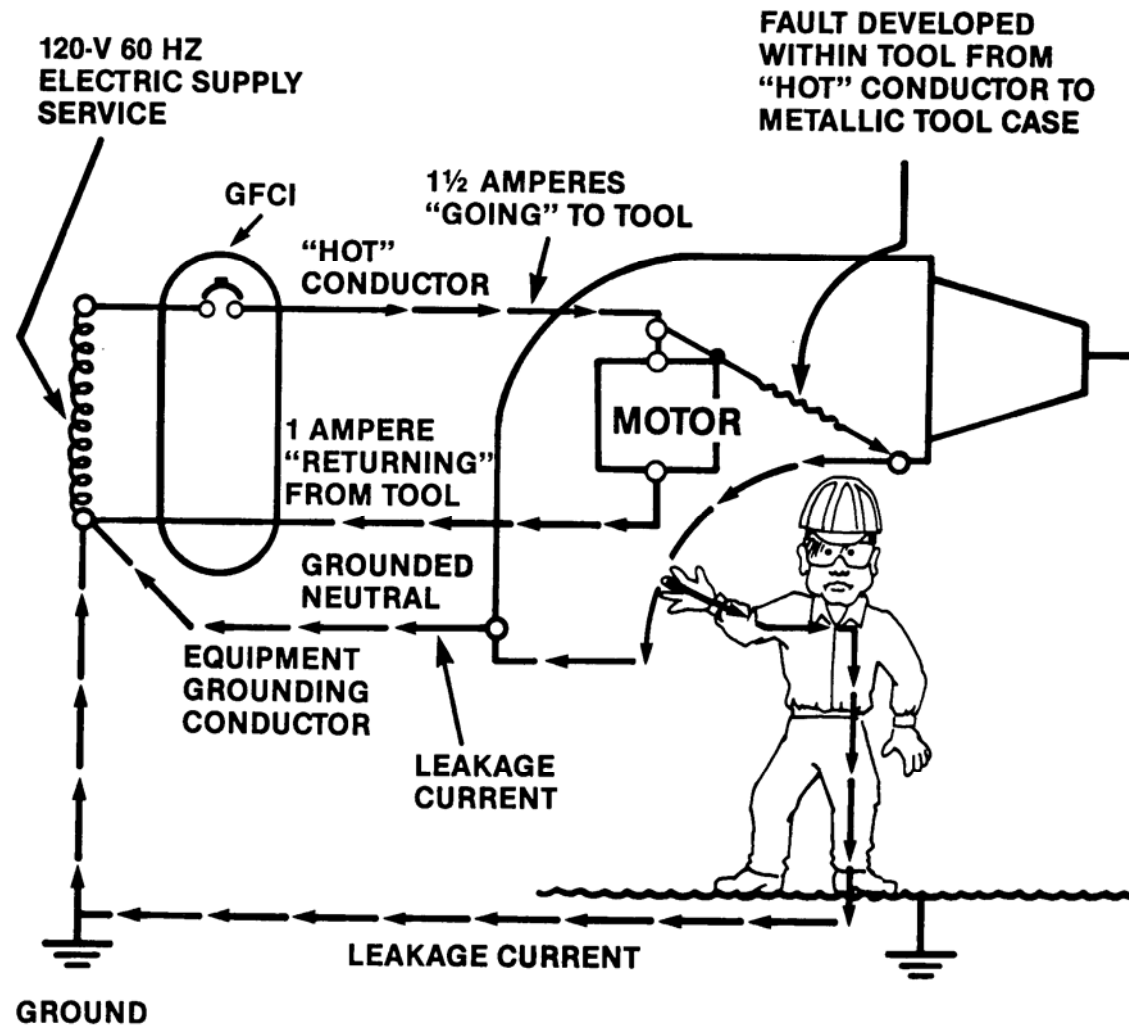

# *Electrical Safety*

- *Avoid contact*

- *Isolate*
- *Insulate*
- *Elevate*

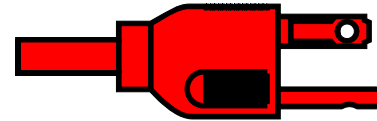
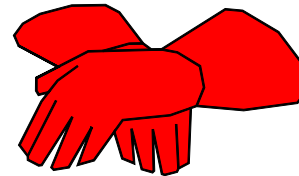
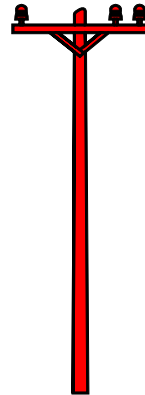

- *Grounding*

- *Ground fault circuit interrupter*

- *Electrical safe work practices*

# *Principles of Electricity*

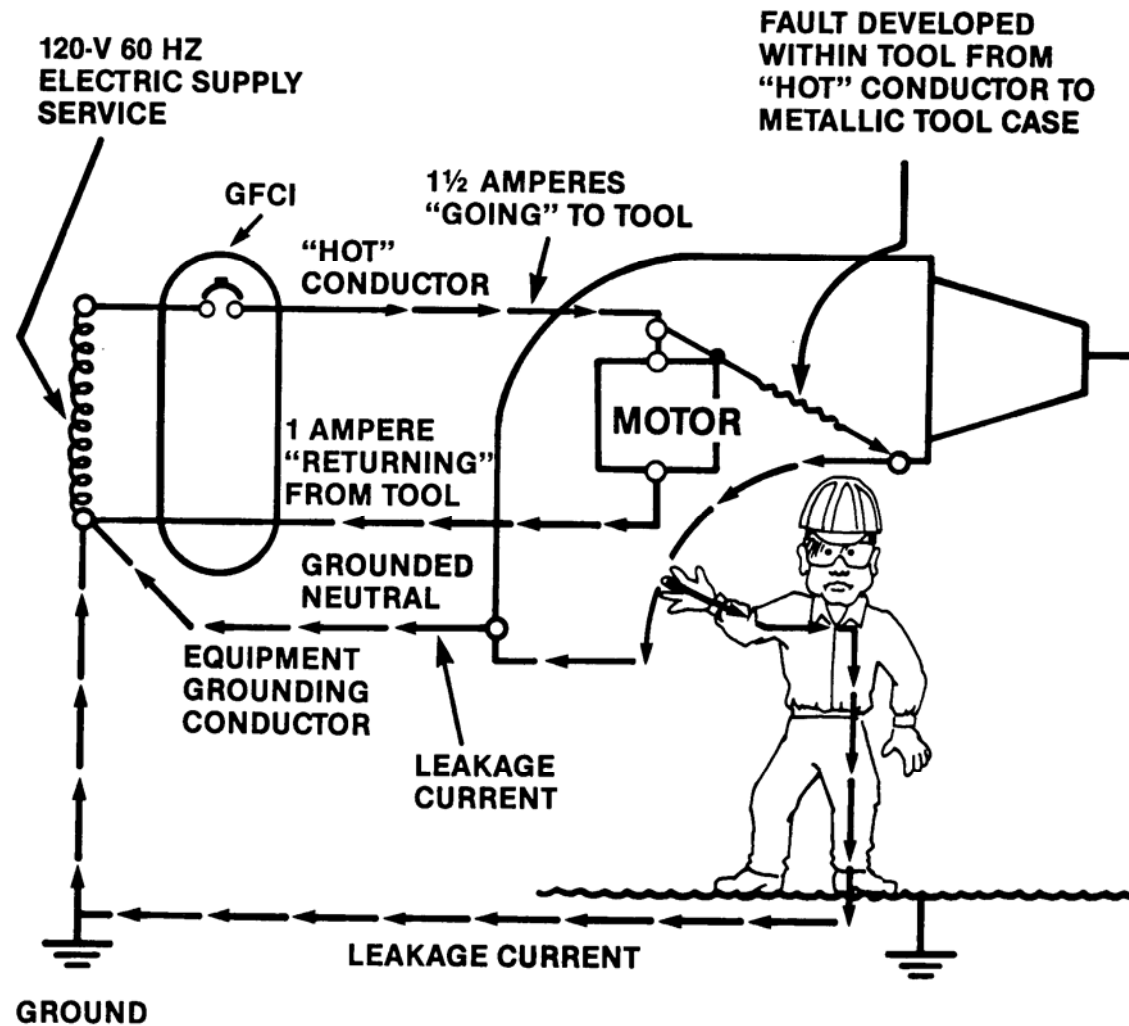

# *GFCI Classes*

---

- *Class A: The most common and is designed to trip when there is a ground fault current of 4 to 6 ma according to UL standard #943*
- *Class B: Only allowed by NFPA 70 (the NEC) to be used in swimming pool installations installed prior to May 1965. The Class B GFCI is designed to trip at a fault current of 20 ma or more*

# *Ground Fault Circuit Interrupter*

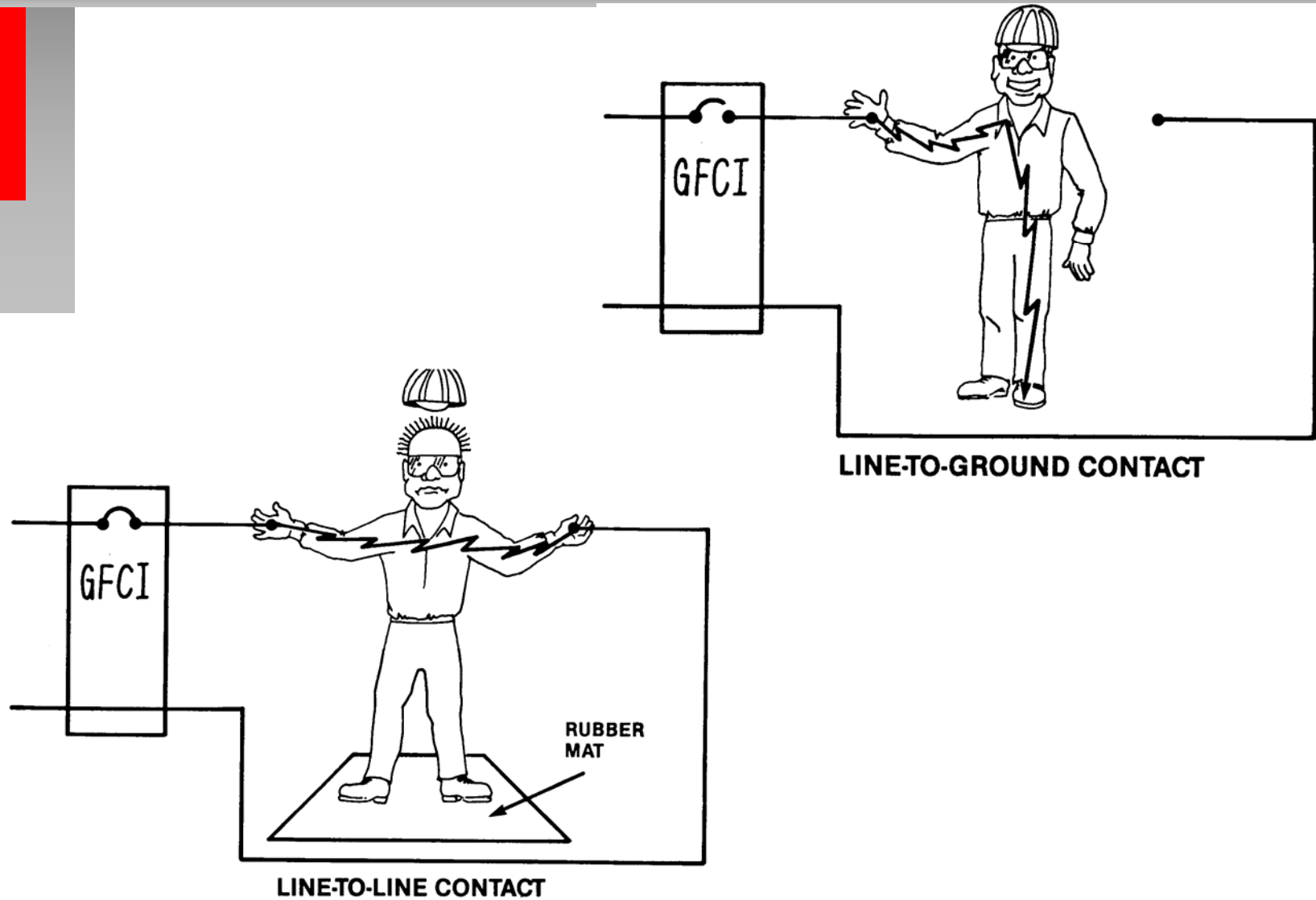

# *Ground Fault Circuit Interrupter*

## ■ *Nuisance Tripping of GFCI*

- *Wet cords; dampness; water*
- *Power tools in poor condition*
- *Excessive length, extension cords*
- *Too many power tools*
- *Bad GFCI*
- *Coiled extension cord*
- *Resistive heater not made for GFCI*
- *Transient voltage spike*

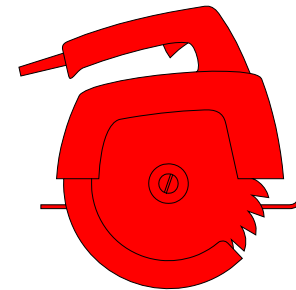

# *Transient Voltage*

- *Variable Frequency Drives*
  - *Motor on air handlers & pumps*
- *Transmission switching*
- *Lighting strikes*

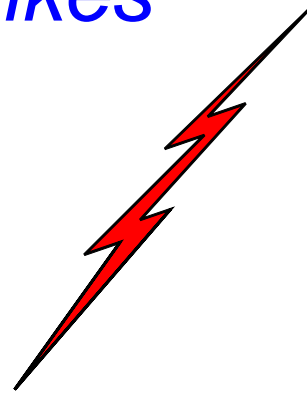
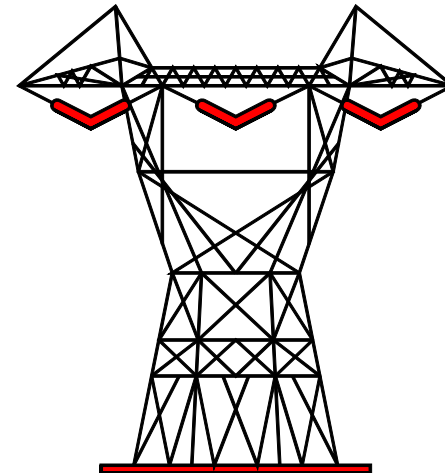
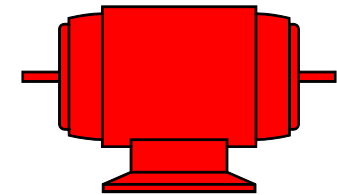

# *Improper Wiring, Effect on GFCI*

<b>GFCI Wiring</b>	<b>GFCI Protects</b>	<b>GFCI test button trips the GFCI</b>	<b>External tester trips the GFCI</b>
Normal	Yes	Yes	Yes
Open ground	Yes	Yes	No
Reverse polarity	Yes	Yes	No
Reverse polarity with open ground	Yes	Yes	No

# *GFCI Protects Downstream Duplexes*

← **Line**   **Load** →

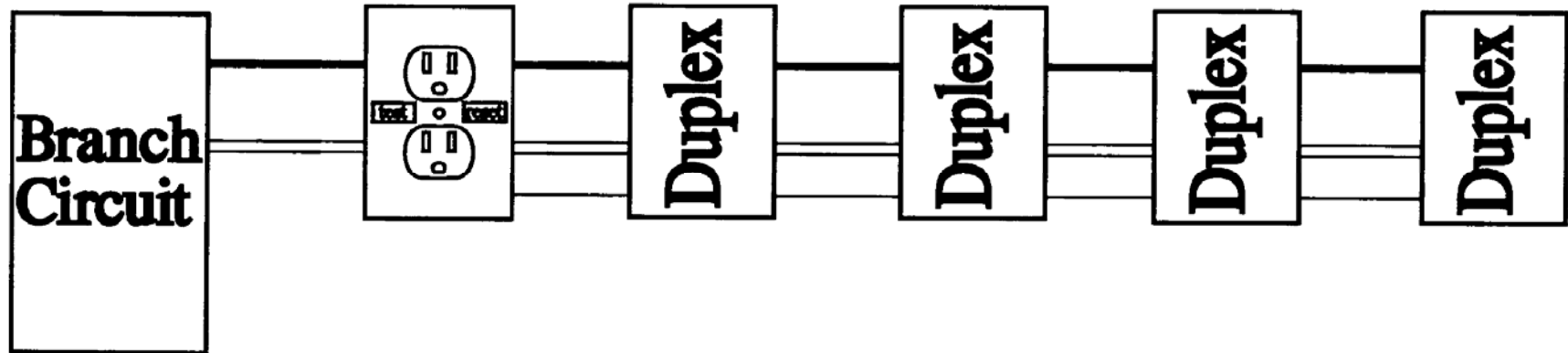

# *Ground Fault Circuit Interrupter - 1926.404*

---

- *(b)(1)(ii) Ground-fault circuit interrupters. All 120-volt, single-phase 15- and 20-ampere receptacle outlets on construction sites, which are not a part of the permanent wiring of the building or structure and which are in use by employees, shall have approved ground-fault circuit interrupters for personnel protection.*

# *Ground Fault Circuit Interrupter - 1926.404*

---

- *(b)(1)(iii) Assured equipment grounding conductor program. The employer shall establish and implement an assured equipment grounding conductor program on construction sites covering all cord sets, receptacles which are not a part of the building or structure, and equipment connected by cord and plug which are available for use or used by employees.*

# *Equipment Grounding Conductor Program*

---

- *Written Description*
- *Competent Person to Implement*
- *Inspection and Test*
- *Record of Tests*

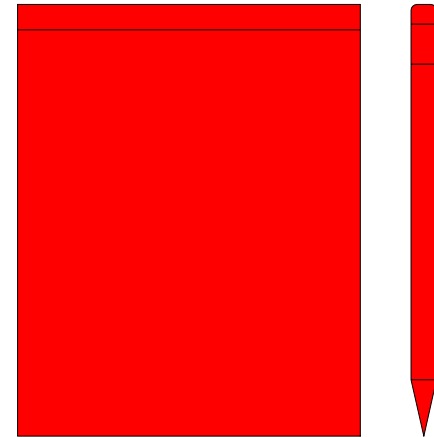

# *Inspections*

---

- *Visual inspection of following:*
  - *Cord sets*
  - *Cap, plug and receptacle of cord sets*
  - *Equipment connected by cord and plug*
- *Exceptions:*
  - *Receptacles and cord sets that refixed and not exposed to damage*
- *Frequency of inspections:*
  - *Before each day's use*

# *Tests*

---

- *Conduct test for:*
  - *Continuity of equipment*
  - *Proper terminal connection equipment grounding conductor*
  
- *Frequency of tests:*
  - *Before first use*
  - *After repair and before placing back in service*
  - *Before use, after suspected damage*
  - *Every 3 months, except that cord sets and receptacles that are fixed and not exposed to damage must be tested at regular intervals not to exceed 6 months*

# *Continuity Test for Grounding Path*

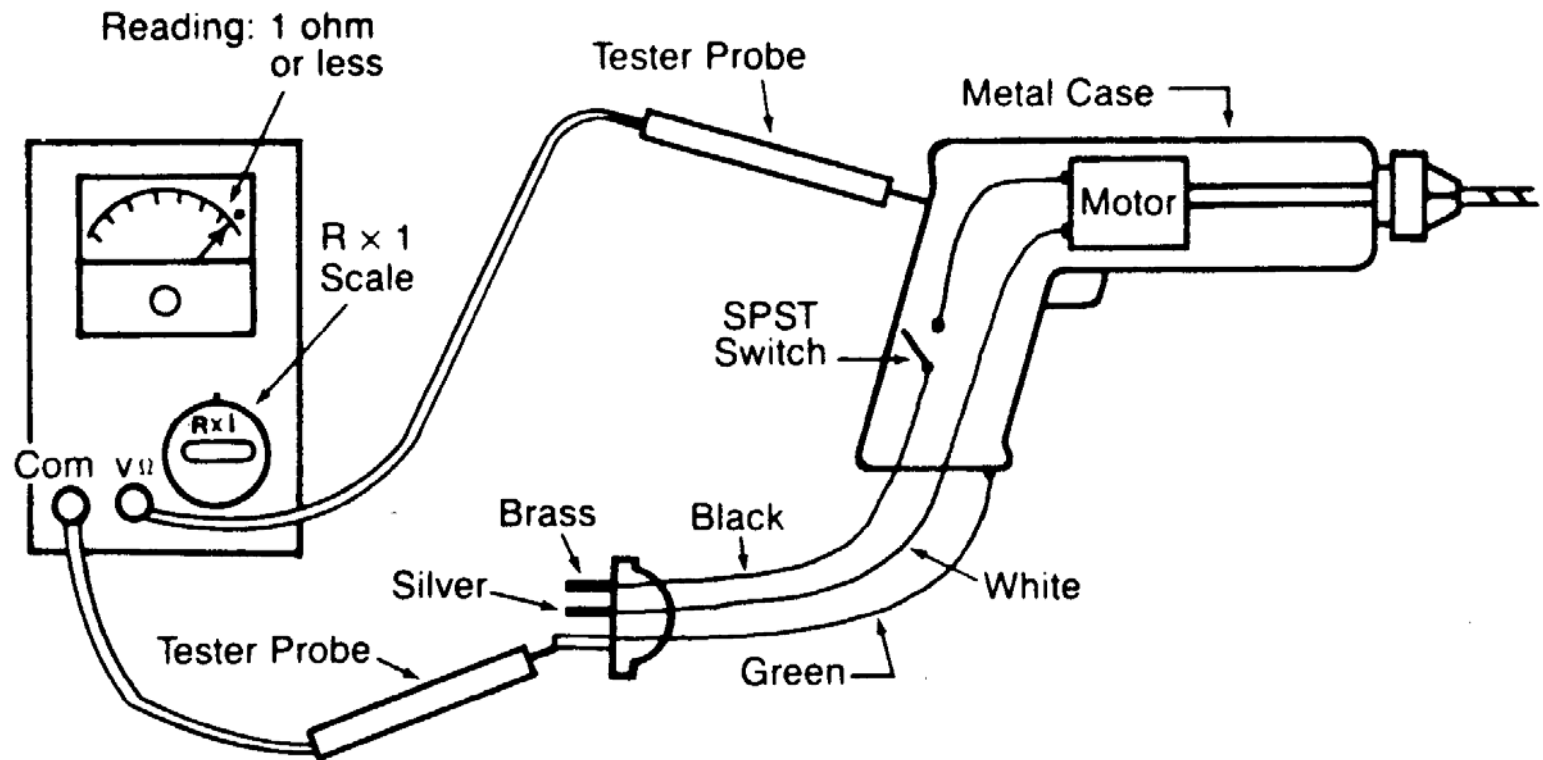

# *Leakage Test for Current to Case*

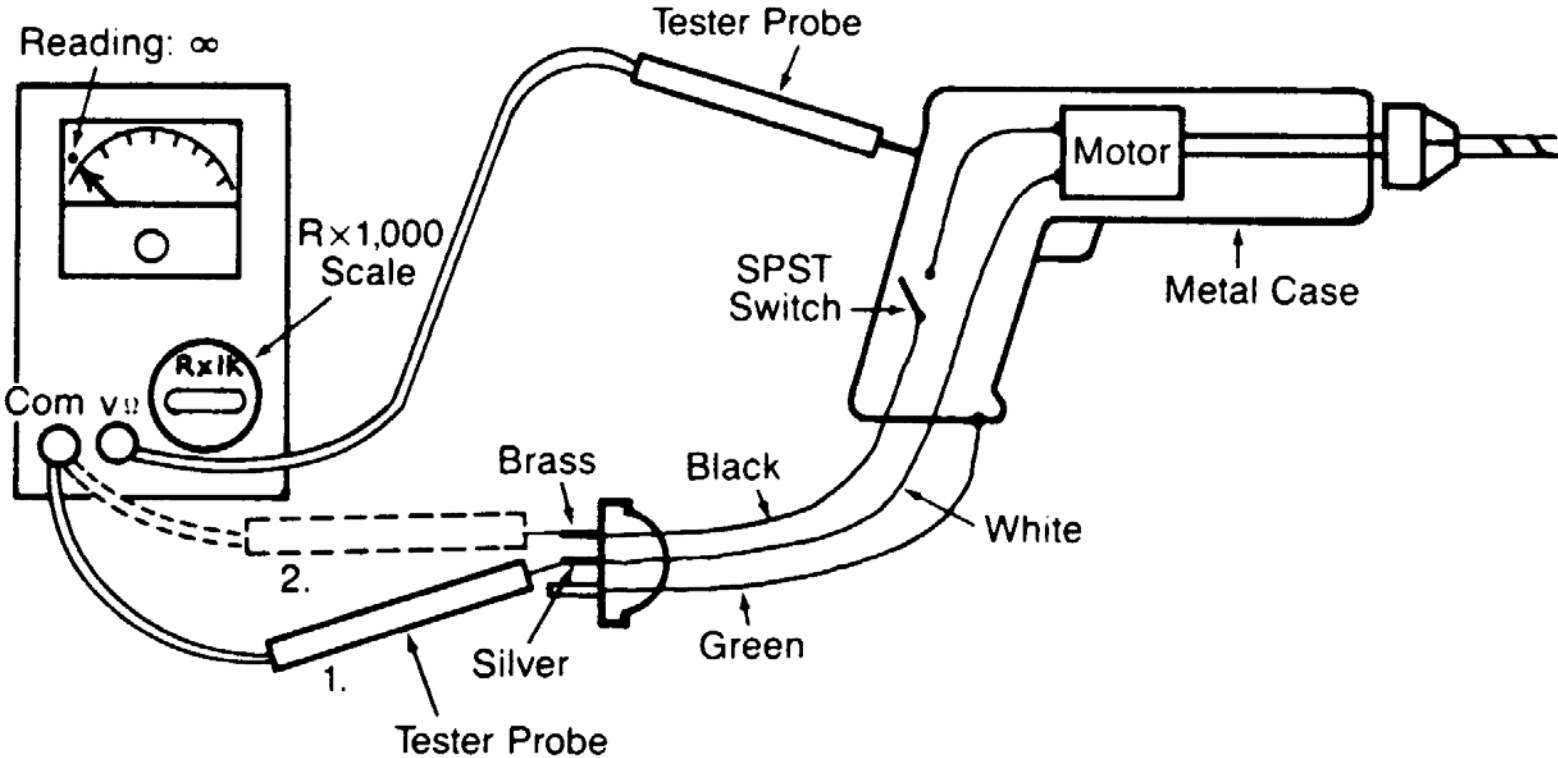

# *Ground Fault Circuit Interrupter - 1926.404*

---

- *Receptacles on a two-wire, single-phase portable or vehicle-mounted generator rated not more than 5kW, where the circuit conductors of the generator are insulated from the generator frame and all other grounded surfaces, need not be protected with ground-fault circuit interrupters.*

# *General Industry 1910 - GFCI*

---

- *1910.306(j)(2)(i) Receptacles. A single receptacle of the locking and grounding type that provides power for a permanently installed swimming pool recirculating pump motor may be located not less than 5 feet from the inside walls of a pool. All other receptacles on the property shall be located at least 10 feet from the inside walls of a pool. Receptacles which are located within 15 feet of the inside walls of the pool shall be protected by ground-fault circuit interrupters.*
- *1910.302(b)(3) The following provisions apply to electric utilization systems and utilization equipment installed after April 16, 1981*

# *Permanently Installed Swimming Pool - GFCI*

*All receptacles  
located within  
15 ft. of the  
pool wall must  
be equipped  
with a GFCI*

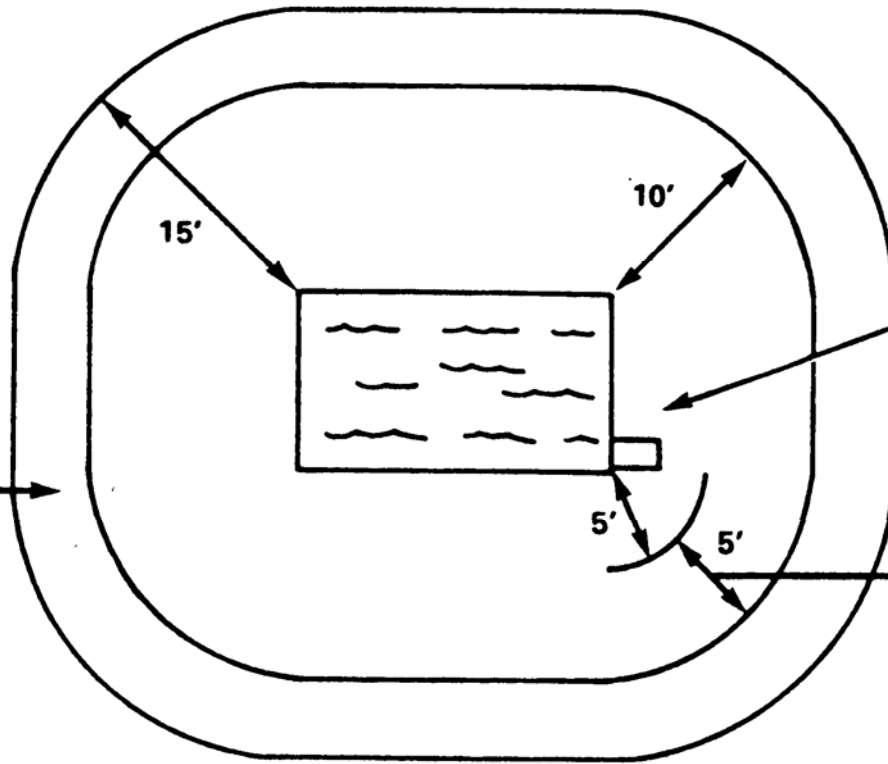

*Receptacles  
not permitted  
within 10 ft. of  
pool wall*

*Only exception is  
a single  
receptacle for  
pool recirculating  
pump motor, but  
must be the  
grounding & twist  
locking type. It  
must be at least  
5 ft. away*

# *General Industry 1910 - GFCI*

---

- *1910.306(j)(5) Fountains. All electric equipment operating at more than 15 volts, including power supply cords, used with fountains shall be protected by ground-fault circuit interrupters.*
- *1910.302(b)(3) The following provisions apply to electric utilization systems and utilization equipment installed after April 16, 1981*

# *New OSHA Requirements*

## *Sec. 1910.304 Wiring design and protection.*

- *(b)(3) Ground-fault circuit interrupter protection for personnel.*
  - *(i) All 125-volt, single-phase, 15- and 20-ampere receptacles installed in bathrooms or on rooftops shall have ground-fault circuit-interrupter protection for personnel.*
    - ***Note 1 to paragraph (b)(3)(ii)(A) of this section:*** *A cord connector on an extension cord set is considered to be a receptacle outlet if the cord set is used for temporary electric power.*
    - Note 2 to paragraph (b)(3)(ii)(A) of this section:*** *Cord sets and devices incorporating the required ground-fault circuit-interrupter that are connected to the receptacle closest to the source of power are acceptable forms of protection.*

# *New OSHA Requirements*

---

- *(ii) The following requirements apply to temporary wiring installations that are used during maintenance, remodeling, or repair of buildings, structures, or equipment or during similar construction-like activities.*
  - *(A) All 125-volt, single-phase, 15-, 20-, and 30-ampere receptacle outlets that are not part of the permanent wiring of the building or structure and that are in use by personnel shall have ground-fault circuit-interrupter protection for personnel.*



## *New OSHA Requirements*

---

- (B) Receptacles other than 125 volt, single-phase, 15-, 20-, and 30-ampere receptacles that are not part of the permanent wiring of the building or structure and that are in use by personnel shall have ground-fault circuit-interrupter protection for personnel.*

# *New OSHA Requirements*

---

- (C) Where the ground-fault circuit-interrupter protection required by paragraph (b)(3)(ii)(B) of this section is not available for receptacles other than 125-volt, single-phase, 15-, 20-, and 30-ampere, the employer shall establish and implement an assured equipment grounding conductor program covering cord sets, receptacles that are not a part of the building or structure, and equipment connected by cord and plug that are available for use or used by employees on those receptacles. This program shall comply with the following requirements:*

# *OSHA General Industry*

## *Subpart S*

---

- *1910.302(a)(2) Not covered. The provisions of §§ 1910.302 through 1910.308 do not cover:*
- *1910.302(a)(2)(iv) Installations of communication equipment under the exclusive control of communication utilities, located outdoors or in building spaces used exclusively for such installations;*

# *Temporary Power Taps*

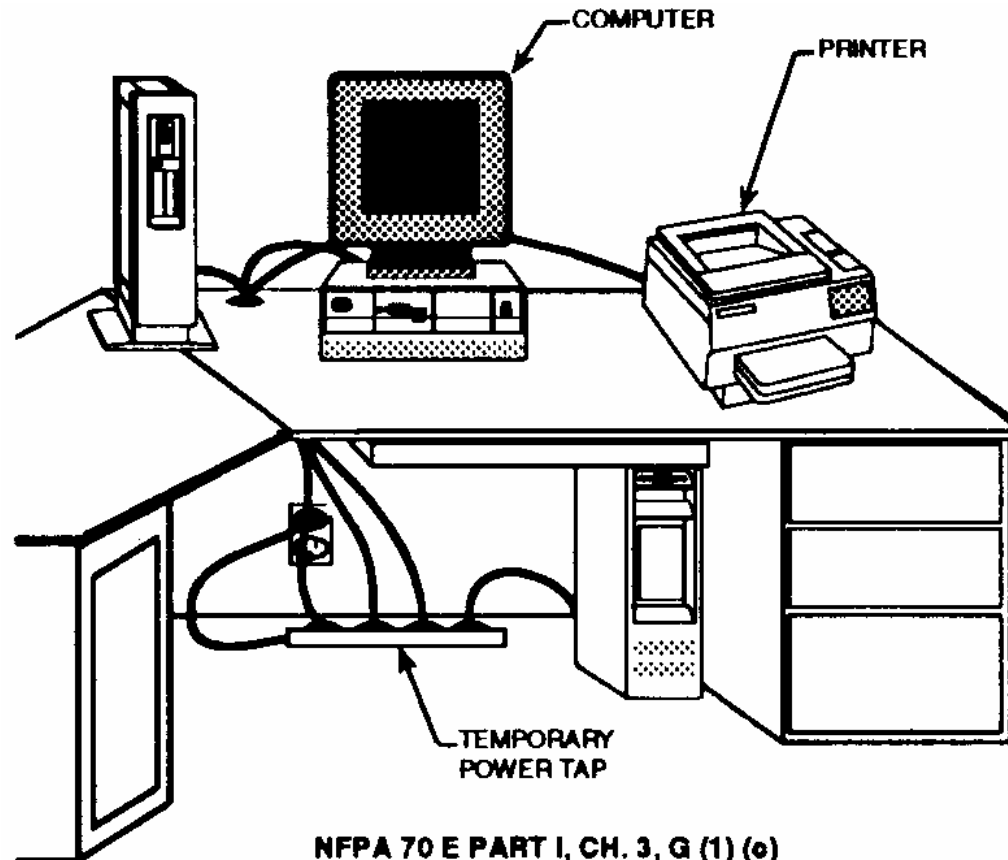

***A number of sensitive electronic pieces of equipment can be plugged into a temporary power tap per UL white book, NEC 90-7, and NEC 110-3(b).***